

# USER MANUAL

## APEX 5220 PRO LFP Battery



## Contents

1 Product Overview .....	1
1.1 Appearance .....	1
1.2 Button, LED & Communication Port .....	2
1.2.2 LED Indicator Definition .....	2
1.2.3 Communication Port Pin Definition .....	4
2 Installation Guide .....	5
2.1 Checking Deliverables .....	5
2.2 Tools .....	6
2.3 Installation Instructions .....	7
3 Bluetooth and Wi-Fi Function .....	12
3.1 Bluetooth .....	12
3.2 Wi-Fi .....	13
4 Technical Specifications .....	15
5 Maintenance .....	16
5.1 Recharge Requirements During Storage .....	16
5.2 Recharge Requirements When Over Discharged .....	16

# 1 Product Overview

APEX 5220 PRO is a 51.2V 102Ah Lithium Iron Phosphate (LiFePO<sub>4</sub>) battery that can be floor mounted, or wall mounted.

**Note: APEX 5220 PRO is not suitable for life-sustaining medical devices.**

## 1.1 Appearance

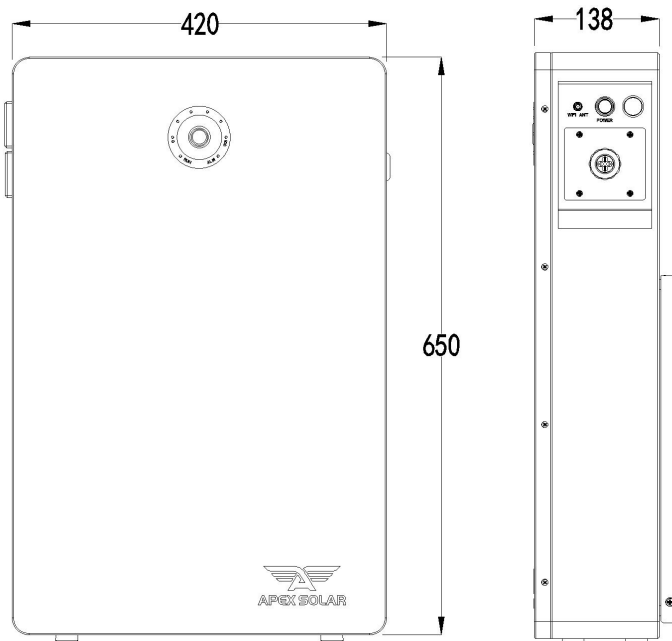

## 1.2 Button, LED & Communication Port

### 1.2.1 Switch ON/OFF

#### 1、Switch ON

For single APEX 5220 PRO, switch ON POWER button, then long press (3 sec) SW button (surrounded by LED lights).

For multiple APEX 5220 PRO connected in parallel, switch ON POWER buttons of all batteries, then long press (3 sec) SW button of master battery.

#### 2、Switch OFF

Switch OFF all POWER button(s).

### 1.2.2 LED Indicator Definition

Note: Flash 1 - 0.25s ON / 3.75s OFF

Flash 2 - 0.5s ON / 0.5s OFF

Flash 3 - 0.5s ON / 1.5s OFF

#### SOC Status while charging

STATUS		CHARGE							
		L8 ●	L7 ●	L6 ●	L5 ●	L4 ●	L3 ●	L2 ●	L1 ●
SOC (%)	0~17	ON	OFF	OFF	OFF	OFF	OFF	OFF	Flash 2
	18~33			OFF	OFF	OFF	OFF	Flash 2	ON
	34~50			OFF	OFF	OFF	Flash 2	ON	ON
	51~66			OFF	OFF	Flash 2	ON	ON	ON
	67~83			OFF	Flash 2	ON	ON	ON	ON
	84~100			Flash 2	ON	ON	ON	ON	ON

### SOC Status while discharging

STATUS		DISCHARGE							
		L8 ●	L7 ●	L6 ●	L5 ●	L4 ●	L3 ●	L2 ●	L1 ●
SOC (%)	0~17	Flash 3	OFF	OFF	OFF	OFF	OFF	OFF	ON
	18~33			OFF	OFF	OFF	OFF	ON	ON
	34~50			OFF	OFF	OFF	ON	ON	ON
	51~66			OFF	OFF	ON	ON	ON	ON
	67~83			OFF	ON	ON	ON	ON	ON
	84~100			ON	ON	ON	ON	ON	ON

### Work Status

STATUS		RUN	ALM	SOC						DESCRIPTION
		L8 ●	L7 ●	L6 ●	L5 ●	L4 ●	L3 ●	L2 ●	L1 ●	
Shutdown		OFF	OFF	OFF	OFF	OFF	OFF	OFF	OFF	
Standby		Flash 1	OFF	According to SOC						
Charge	Normal	ON	OFF	According to SOC						
	Over volt	ON	OFF	ON	ON	ON	ON	ON	ON	Switch to standby mode
	Protection	OFF	ON	OFF	OFF	OFF	OFF	OFF	OFF	Stop charging
Discharge	Normal	Flash 3	OFF	According to SOC						
	Under volt	OFF	OFF	OFF	OFF	OFF	OFF	OFF	OFF	Stop discharging
	Protection	OFF	ON	OFF	OFF	OFF	OFF	OFF	OFF	Stop discharging
Faulty		OFF	ON	OFF	OFF	OFF	OFF	OFF	OFF	Stop charging and discharging

### 1.2.3 Communication Port Pin Definition

#### 1.2.3.1 CAN/RS485 to PCS

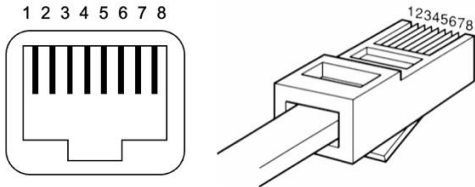
Port definitions	RJ45 Pin	Function
	1	RS485-B
	2	RS485-A
	3	GND
	4	CAN-H
	5	CAN-L
	6	NC
	7	RS485-A
	8	RS485-B



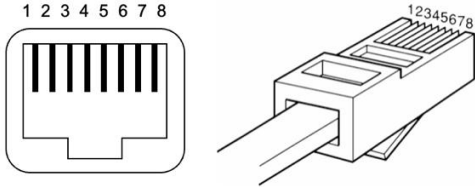



#### 1.2.3.2 RS232 to PC

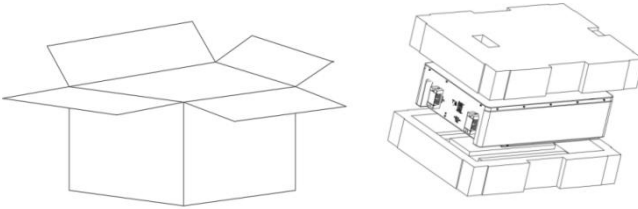

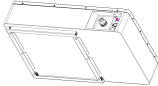
Port definitions	RJ45 Pin	Function
	1	RS232-TX
	2	GND
	3	RS232-RX
	4	NC
	5	NC
	6	NC
	7	NC
	8	NC

## 2 Installation Guide







### 2.1 Checking Deliverables

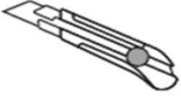
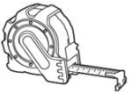
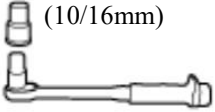

NO.	Pictures	Quantity	Description
1		1 pc	APEX 5220 PRO Battery
2		4 pcs	Battery hanging bolt
3		4 pcs	Battery hanger
4		1 pc	Wall Mount
5		2 pcs	Wall Mount Bottom Bolt
6		4 pcs	Expansion Bolt

7		1 pc	User Manual
8		1 pc	Comm cable

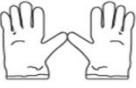
## 2.2 Tools

<b>Installation Tools</b>	<p>Knife</p> 	<p>Measuring Tape</p> 	<p>Socket Wrench (10/16mm)</p> 
	<p>Hammer</p> 	<p>Cross Screwdriver</p> 	<p>Hammer Drill</p> 
<b>Protection Tools</b>	<p>ESD Gloves</p> 	<p>Safety Goggles</p> 	<p>Safety Shoes</p> 



## 2.3 Installation Instructions

### Minimum mounting distance requirement: (Wall Mounted)

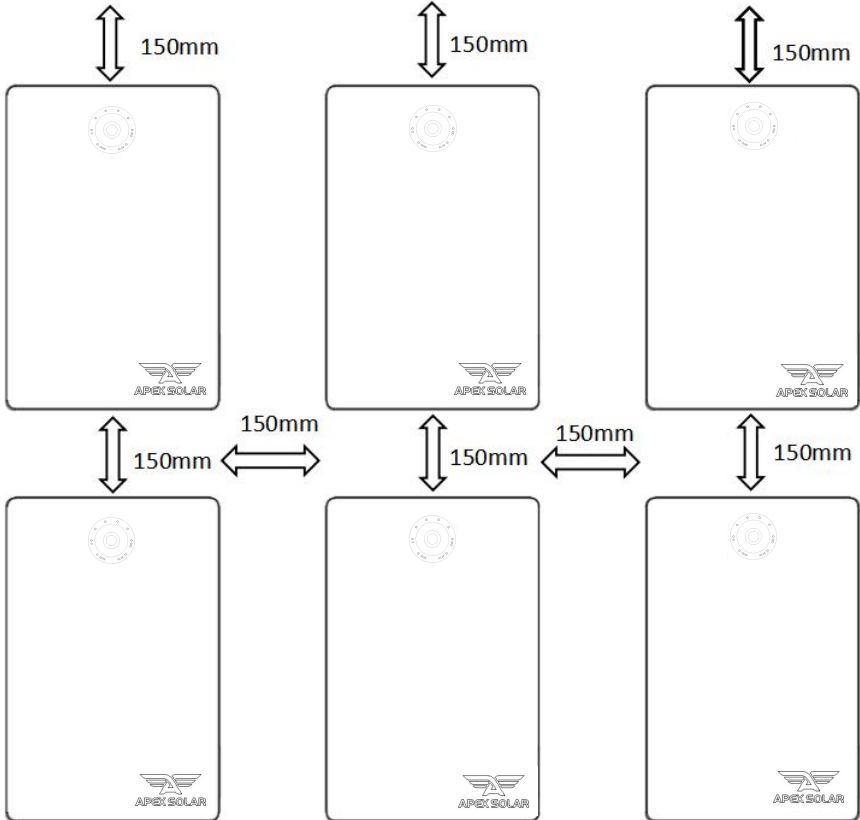

### 2.3.1 Installation Step (Floor Mounted)

#### Step 1

put APEX 5220 PRO on floor then start from Step 6

### 2.3.2 Installation Step (Wall Mounted)

#### Step 1

Remove 2 pcs wall mount bottom bolts, remove wall mount from battery.

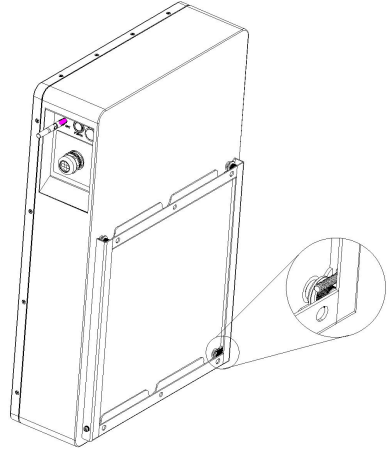

#### Step 2

Drill holes in the wall according to wall mount.



#### Step 3

Fix wall mount to the wall using expansion bolt.

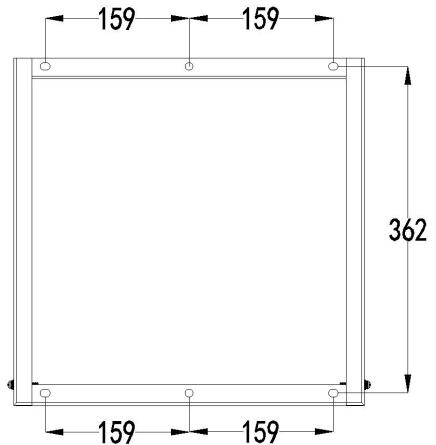

**Step 4**

Hang APEX 5220 PRO battery on wall mount.

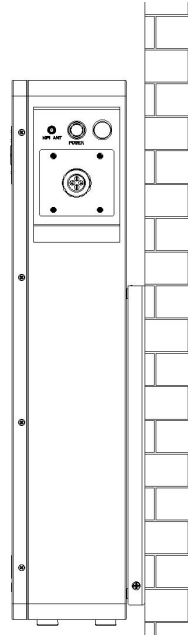
**Step 5**

Install 2 pcs wall mount bottom bolts.

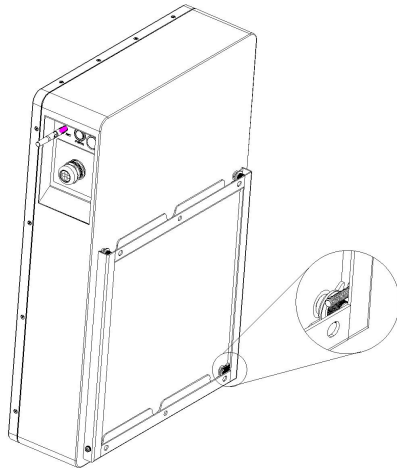

**Step 6** Connect PE cable & power cable.

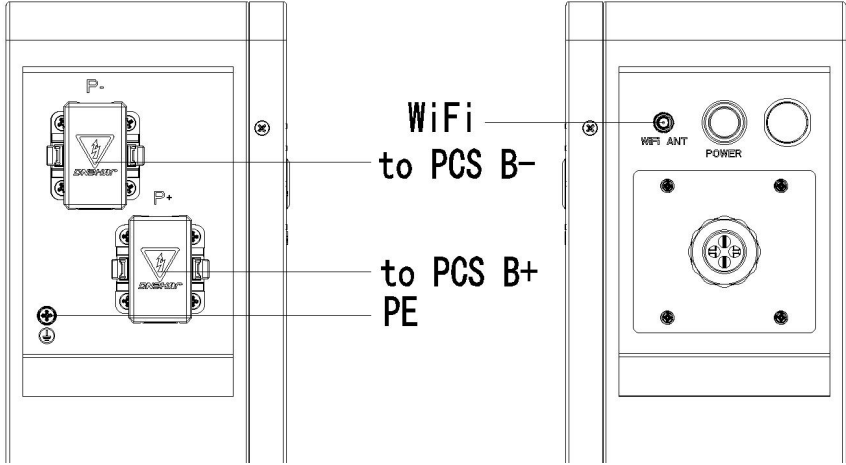

**Step 7** Connect communication cable.

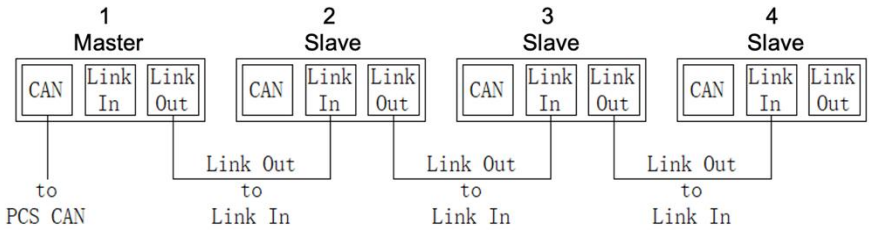

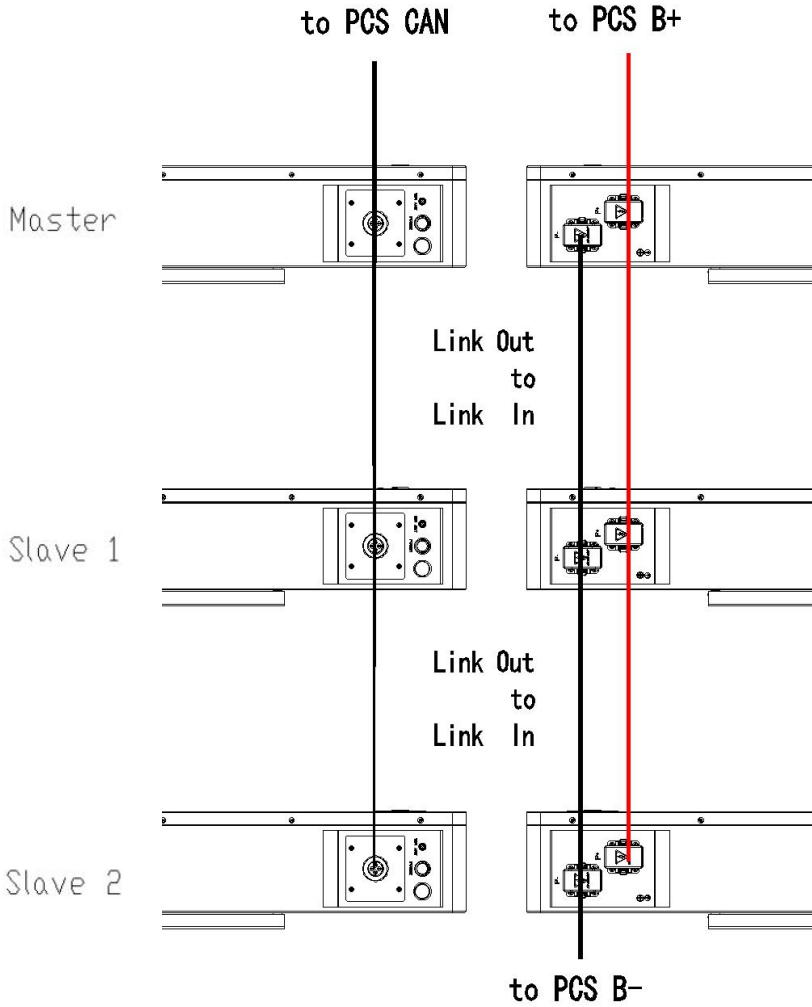

**Step 8** Refer to the following diagram when multiple batteries are connected in parallel:

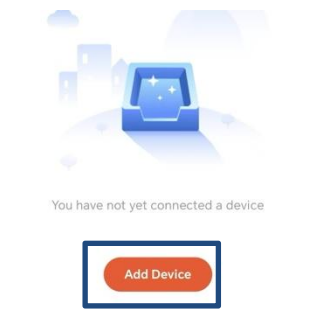

## 3 Bluetooth and Wi-Fi Function

### 3.1 Bluetooth

<p>1. Turn on Bluetooth function on your phone, open “APEX SOLAR” APP, tap “BLE”</p> 	<p>2. Tap “Add Device”</p> 
<p>3. Select your APEX SOLAR device and connect</p> 	<p>4. Check APEX SOLAR battery info on your phone</p> 

### 3.2 Wi-Fi

1) Connect your phone to Wi-Fi, open “APEX SOLAR” APP, tap “WiFi”

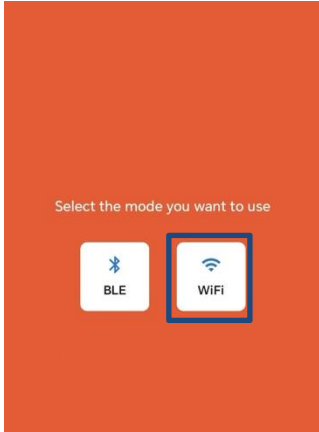

2) Tap “Sign Up”

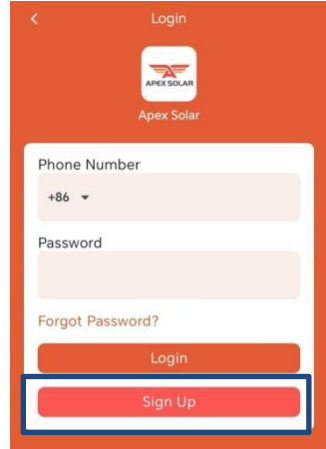

3) Create your account and login

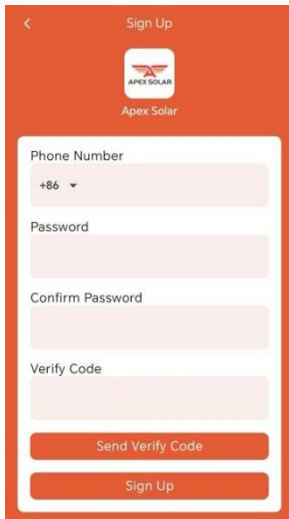

4) Tap “Add Device”

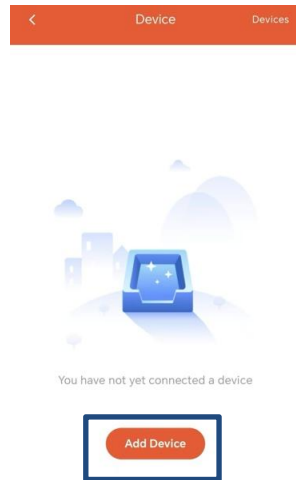

5) select your APEX SOLAR device and connect

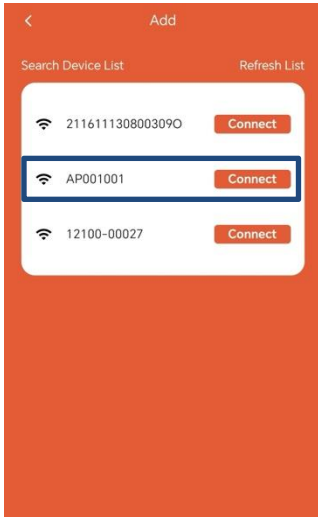

6) Permission code 5181

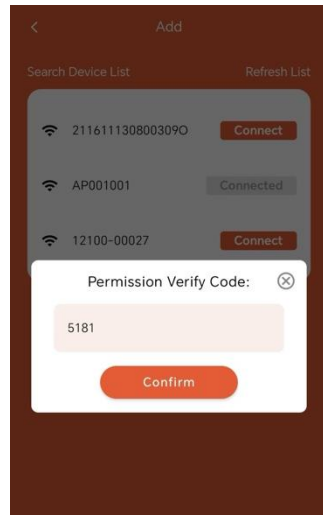

7) Confirm your WiFi Name and enter your WiFi password



8) Check APEX SOLAR battery info on your phone

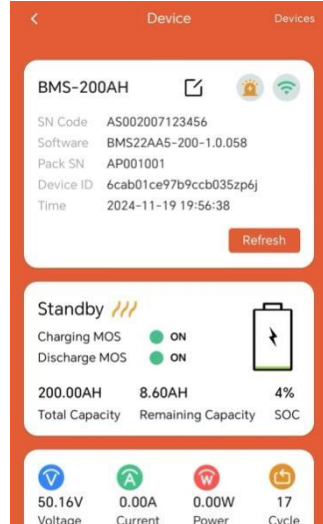



## 4 Technical Specifications

Basic Project		Parameter
Nominal Voltage		51.2V
Nominal Capacity		102Ah
Nominal Energy		5220Wh
Charge Voltage		56.16V
Charge Current		50A
Discharge Voltage Range		45.6V~56.16V
Discharge Current		100A
Communication Mode		CAN/RS485
Working Temperature	Charge	0°C~55°C
	Discharge	-20°C~55°C
Storage Temperature	Short Term (within 1 month)	-10°C~45°C
	Long Term (within 1 year)	0°C~35°C
Storage Humidity		<95% RH
Cell Type		LiFePO <sub>4</sub> , Lithium Iron Phosphate
Size		H650*W420*D138(mm)
Weight		47.2KG (Wall Bracket Included)
IP Level		IP66

## 5 Maintenance

### 5.1 Recharge Requirements During Storage

Batteries should be stored in temperature between  $-10^{\circ}\text{C} \sim +45^{\circ}\text{C}$ , and recharged regularly according to the following table with 0.2C (20A) current to 50% SOC after long time storage.

#### Recharge requirement during storage

Storage Temperature	Storage Relative Humidity	Storage Time	SOC
Below $-10^{\circ}\text{C}$	/	Not Allowed	/
$-10\sim 25^{\circ}\text{C}$	5%~70%	$\leq 12$ months	$30\% \leq \text{SOC} \leq 60\%$
$25\sim 35^{\circ}\text{C}$	5%~70%	$\leq 6$ months	$30\% \leq \text{SOC} \leq 60\%$
$35\sim 45^{\circ}\text{C}$	5%~70%	$\leq 3$ months	$30\% \leq \text{SOC} \leq 60\%$
Above $45^{\circ}\text{C}$	/	Not Allowed	/

### 5.2 Recharge Requirements When Over Discharged

Please recharge over discharged ( $>90\%$  DOD) batteries according to the following table, otherwise over discharged battery will be damaged.

#### Recharge requirement when battery is over discharged

Storage Temperature	Storage Time	Note
$-10\sim 25^{\circ}\text{C}$	$\leq 15$ days	Battery disconnected from PCS
$25\sim 45^{\circ}\text{C}$	$\leq 7$ days	
$-10\sim 45^{\circ}\text{C}$	$< 12$ hours	Battery connected to PCS